

Features

- Cross handle
- Single handle provides on/off activation and volume control
- Part of the Occasion bathroom faucet and accessory collection

Material

- Premium material construction with metal handle ensures reliability and durability
- KOHLER finishes resist corrosion and tarnishing

Installation

- Patented K-joint installation technology ensures consistent trim appearance, regardless of variability in valve rough-in
- Wall-mount
- Trim only; requires valve to complete installation (sold separately)



ADA **CSA B651** **OBC**

Codes/Standards







ASME A112.18.1/CSA B125.1
 ADA
 ICC/ANSI A117.1
 CSA B651
 OBC

KOHLER® Faucet Lifetime Limited Warranty

See website for detailed warranty information.

Available Colors/Finishes

Color tiles intended for reference only.

Color	Code	Description
	CP	Polished Chrome
	SN	Vibrant™ Polished Nickel
	BN	Vibrant™ Brushed Nickel
	BL	Matte Black
	2MB	Vibrant™ Brushed Moderne Brass
	BMB	Matte Black with Moderne Brass

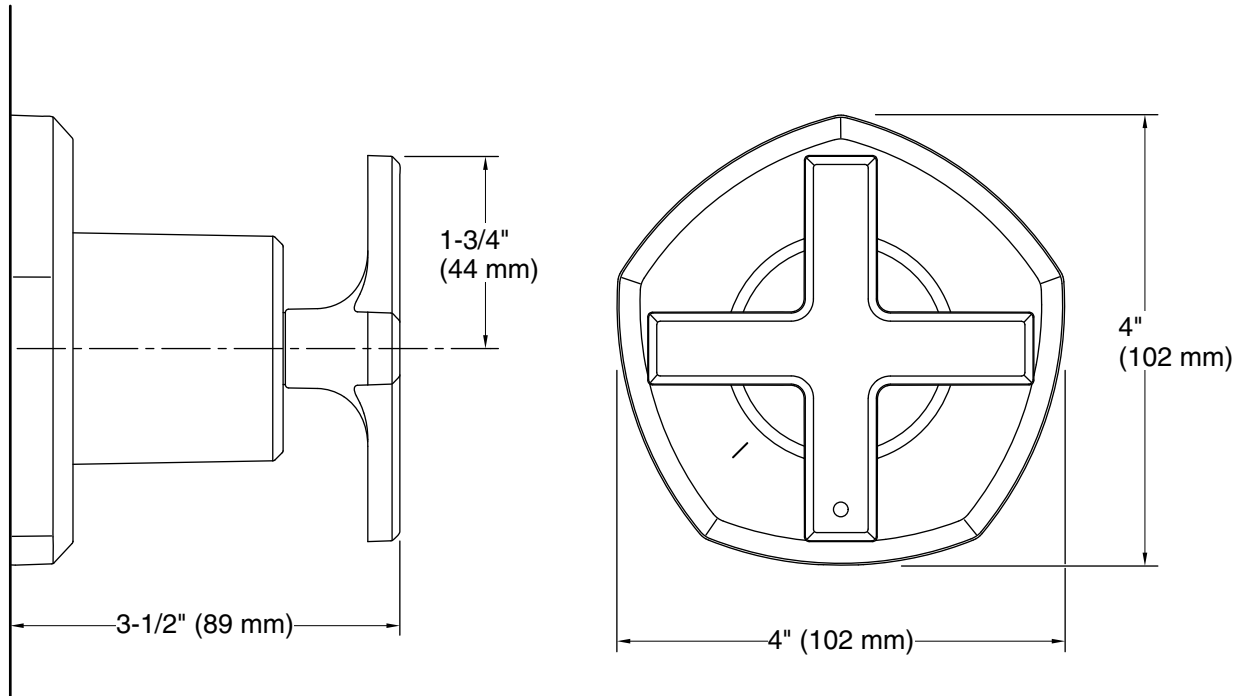

Technical Information

All product dimensions are nominal.

Drain included: No

Notes

ADA, OBC, CSA B651 compliant when installed to the specific requirements of these regulations.